



GAZZDA

Nora seating

Product sheet

design by
Mustafa Čohadžić



**BIGSEE
PRODUCTDESIGN
AWARD 2019
WINNER**

Nora seating

Product facts

Materials

Body	Solid oak
Backrest	Oak veneer
Finish	Hardwax oil / lacquered
Seat	Oak veneer / leather or fabric upholstery

Technical features

Body

Nora's body is made out of solid wood, while the bent backrest is made out of thin veneer slices of high-quality oak. Chair elements are connected with characteristic and visible wedged mortise and tenon joints. Plastic gliders are attached to the chair legs and are suitable for most flooring options. The seat is connected to the body through black seat spacers, while the backrest is attached to the chair legs with black powder-coated spacers.

Seat

Three material options for a seat are available: as a form-pressed veneer seat or as leather or fabric upholstered options. For further information please see Available materials page in this document.

Finish

Wooden parts are available in two plant-based Hardwax oil finishes (colours), which retain the wood's natural state, as a white or natural oil or two dark-colored lacquered options as a Charcoal or Black.

Cleaning

Please see [Product](#) or [Material](#) page on our website.

Standards and certifications

Nora Chair, Nora Lounge Chair and Nora Bar Chair fulfil requirements of standard BAS EN 16139:2014 + BAS EN 16139/Cor1:2014 Furniture - Strength, durability and safety - Requirement for non-domestic seating.

Notes to consider

Variations

Natural variations in wood color and surface may occur. Regular maintenance will ensure the wood preserves its authentic beauty and can last for generations.

Product changes

Please note that Gazzda reserves the right to alter construction and design without notice.

Dimensions (tolerances)

The dimensions shown are indicative, they may vary due to the natural properties of wood, season, or manufacturing processes. Deviations from the specified size may occur, usually no more than 1 cm.

For all additional inquiries regarding Nora seating products please feel free to [contact us](#).

Nora Chair

Base Solid Oak, Backrest Oak veneer, Seat Upholstered / Oak veneer



Version: 1-1-2023

Basic info

Design	Mustafa Čohadžić
Product size	W: 45, D: 47, H: 79
Packaging	W: 51,5, D: 66,5, H: 103
Volume	0,35 m ³
Net weight	5,9 kg
Gross weight	14,2 kg (2 pcs per packaging)

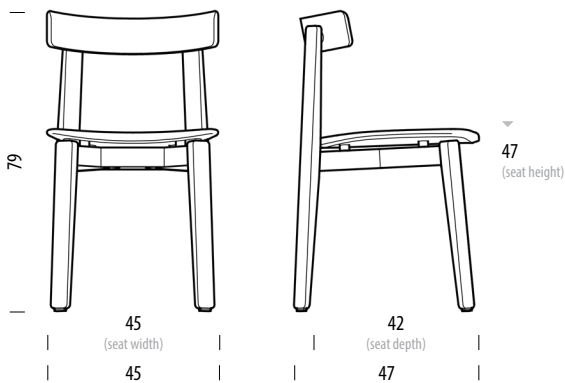

Item no. 0FF / 1D1

Assembled product

Dimensions	Width	Depth	Height
Seat	45	42	47

Selected options

Body



Oiled Oak
1015 / 1505
White / Natural



Lacquered
RAL 9005
Black



Oiled Oak
1015
White oil

Veneer seat



Oiled Oak
1015 / 1505
White / Natural



Oiled Oak
1015
White oil

Fabric / leather upholstery



Main line flax
MLF02
Archway



Dakar leather
2732
Whisky

Indicated materials and colours are selected by Gazzda as best-selling items and their lead time is shorter than of made-to-order options. Please consult the current price list or our customer service for the lead time of selected options.

For other material options, please see the Available materials section at the end of the product sheet.

Nora Lounge Chair

Base Solid oak, Backrest Oak veneer, Seat Upholstered / Oak veneer

Basic info

Design	Mustafa Čohadžić
Product size	W: 59, D: 56, H: 73
Packaging	W: 66, D: 60,5, H: 78
Volume	0,31 m ³
Net weight	7,2 kg
Gross weight	10,3 kg

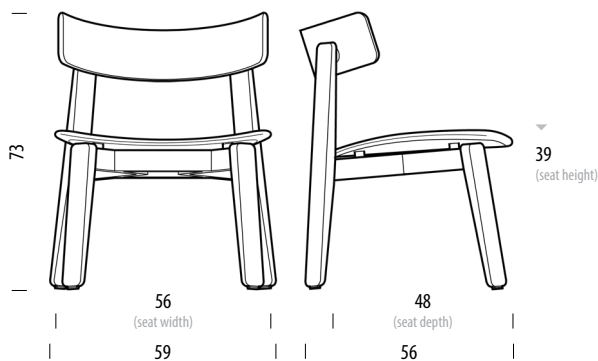

Item no. 184 / 1D2

Assembled product

Dimensions	Width	Depth	Height
Seat	56	48	39

Selected options

Body



Oiled Oak
1015 / 1505
White / Natural



Lacquered
RAL 9005
Black



Oiled Oak
1015
White oil

Veneer seat



Oiled Oak
1015 / 1505
White / Natural



Oiled Oak
1015
White oil

Fabric / leather upholstery



Main line flax
MLF02
Archway



Dakar leather
2732
Whisky

Indicated materials and colours are selected by Gazzda as best-selling items and their lead time is shorter than of made-to-order options. Please consult the current price list or our customer service for the lead time of selected options.

For other material options, please see the Available materials section at the end of the product sheet.

Nora Lounge Chair Upholstered Backrest

Base **Solid oak**, Seat / backrest **Upholstered**

Basic info

Design Mustafa Čohadžić

Product size W: 59, D: 56, H: 73

Packaging W: 66, D: 60,5, H: 78

Volume 0,31 m³

Net weight 8 kg

Gross weight 11,1 kg

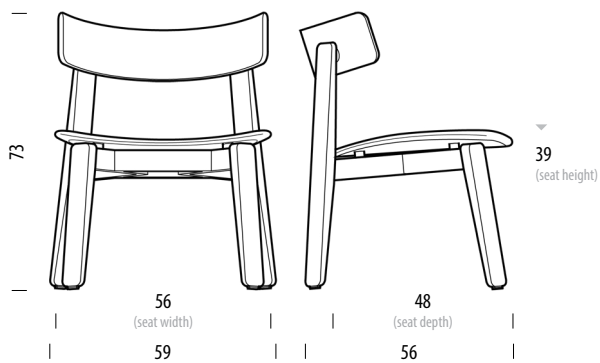

Item no. 1D3

Assembled product

Dimensions	Width	Depth	Height
Seat	56	48	39

Nora Stool

Base Solid oak, Seat Upholstered / Oak veneer

Basic info

Design Mustafa Čohadžić

Product size W: 55, D: 40, H: 43

Packaging W: 58, D: 50, H: 44

Volume 0,13 m³

Net weight 4,9 kg

Gross weight 6 kg

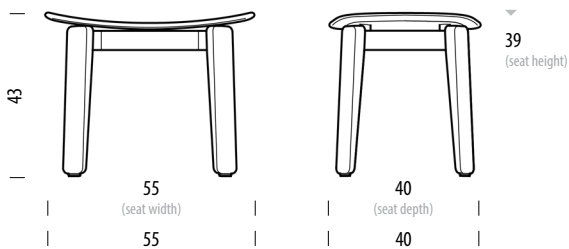

Item no. 1DF / 1E0

Assembled product

Dimensions	Width	Depth	Height
Seat	55	40	39

Selected options

Body



Oiled Oak
1015 / 1505
White / Natural



Lacquered
RAL 9005
Black



Oiled Oak
1015
White oil

Veneer seat



Oiled Oak
1015 / 1505
White / Natural



Oiled Oak
1015
White oil

Fabric / leather upholstery



Main line flax
MLF02
Archway



Dakar leather
2732
Whisky

Indicated materials and colours are selected by Gazzda as best-selling items and their lead time is shorter than of made-to-order options. Please consult the current price list or our customer service for the lead time of selected options.

For other material options, please see the Available materials section at the end of the product sheet.

Nora Bar Chair

Base Solid Oak, Backrest Oak veneer, Seat Upholstered / Oak veneer

Basic info

Design Mustafa Čohadžić

Product size W: 46, D: 45, H: 100

Packaging W: 52, D: 47, H: 106

Volume 0,26 m³

Net weight 7,7 kg

Gross weight 10,1 kg

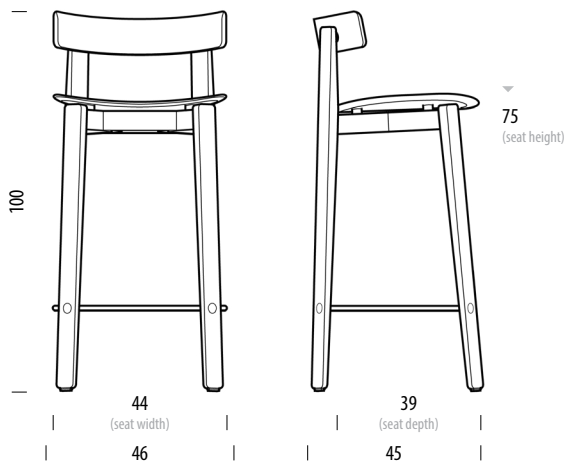

Item no. 185 / 1CE

Assembled product

Dimensions	Width	Depth	Height
Seat	44	39	75

Nora Bar Stool

Base Solid oak, Seat Upholstered / Oak veneer

Version: 1-1-2023

Basic info

Design Mustafa Čohadžić

Product size W: 46, D: 45, H: 100

Packaging W: 52, D: 47, H: 106

Volume 0,26 m³

Net weight 7,7 kg

Gross weight 10,1 kg

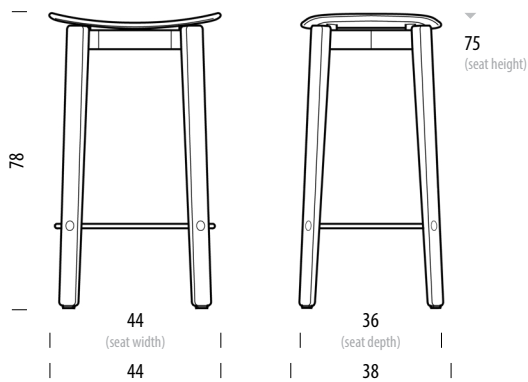

Item no. 187 / 1D0

Assembled product

Dimensions	Width	Depth	Height
Seat	44	36	75

Nora Counter Chair

Base Solid Oak, Backrest Oak veneer, Seat Upholstered / Oak veneer

Basic info

Design	Mustafa Čohadžić
Product size	W: 46, D: 44, H: 90
Packaging	W: 52, D: 47, H: 106
Volume	0,26 m ³
Net weight	7,2 kg
Gross weight	9,6 kg

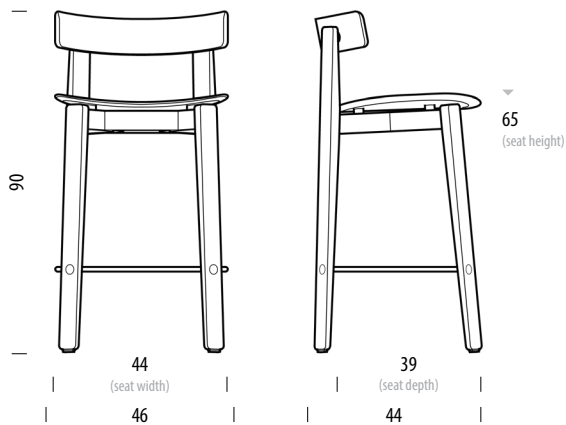

Item no. 186 / 1CD

Assembled product

Dimensions	Width	Depth	Height
Seat	44	39	65

Selected options

Body



Oiled Oak
1015 / 1505
White / Natural



Lacquered
RAL 9005
Black



Oiled Oak
1015
White oil

Veneer seat



Oiled Oak
1015 / 1505
White / Natural



Oiled Oak
1015
White oil

Fabric / leather upholstery



Main line flax
MLF02
Archway



Dakar leather
2732
Whisky

Indicated materials and colours are selected by Gazzda as best-selling items and their lead time is shorter than of made-to-order options. Please consult the current price list or our customer service for the lead time of selected options.

For other material options, please see the Available materials section at the end of the product sheet.

Nora Counter Stool

Base Solid oak, Seat Upholstered / Oak veneer

Basic info

Design Mustafa Čohadžić

Product size W: 44, D: 37, H: 68

Packaging W: 51, D: 49, H: 89

Volume 0,22 m³

Net weight 5,7 kg

Gross weight 8,1 kg

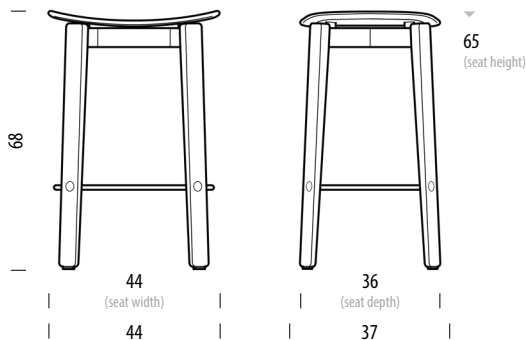

Item no. 188 / 1CF

Assembled product

Dimensions	Width	Depth	Height
Seat	44	36	65

Selected options

Body



Oiled Oak
1015 / 1505
White / Natural



Lacquered
RAL 9005
Black



Oiled Oak
1015
White oil

Veneer seat



Oiled Oak
1015 / 1505
White / Natural



Oiled Oak
1015
White oil

Fabric / leather upholstery



Main line flax
MLF02
Archway



Dakar leather
2732
Whisky

Indicated materials and colours are selected by Gazzda as best-selling items and their lead time is shorter than of made-to-order options. Please consult the current price list or our customer service for the lead time of selected options.

For other material options, please see the Available materials section at the end of the product sheet.

Nora seating

Available materials

Version: 1-1-2023

Body | Oak

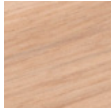

Oiled
1015
White oil

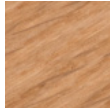

Oiled
1505
Natural oil

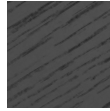

Lacquered
RAL 9005
Black

Seat | Leather upholstery

Dakar - by Leder Reinhard

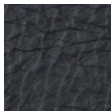

0500
Black



1258
Grey



1436
Stone

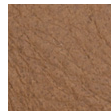

3411
Nature

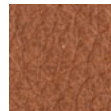

2732
Whisky

Deca vegan leather - by Camira

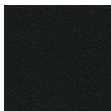

DEC20
Downing

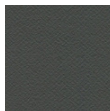

DEC05
Decimal

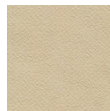

DEC03
Digit



DEC07
Decapod



DEC14
Fortune

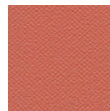

DEC09
Tien



DEC11
Richter

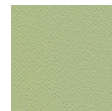

DEC15
Catenia

Seat | Fabric upholstery

Main line flax - by Camira



MLF16
Temple



MLF20
Upminster

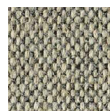

MLF02
Archway



MLF10
Newbury

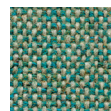

MLF24
Bayswater

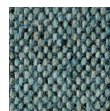

MLF22
Westminster

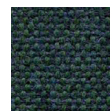

MLF32
Greenford

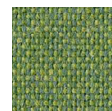

MLF18
Tufnell

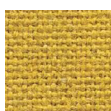

MLF17
Tooting

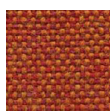

MLF13
Leyton

Nora seating

Available materials

Version: 1-1-2023

Era - by Camira

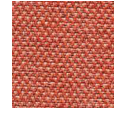
CSE14
ForwardCSE13
PresentCSE45
PromptCSE42
RangeCSE20
AeonCSE16
TimelapseCSE26
TurnCSE03
Lifetime

Relate - by Kvadrat

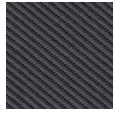

0171

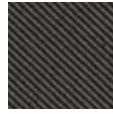

0181

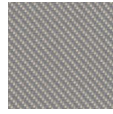

0111



0771



0961

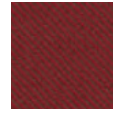

0671

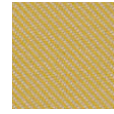

0431

Remix - by Kvadrat



0753

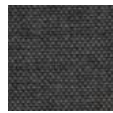

0163

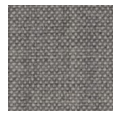

0123



0823

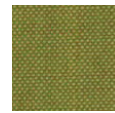

0912

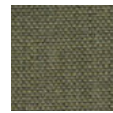

0933



0612

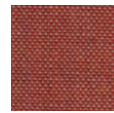

0632



0762

Oceanic - by Camira

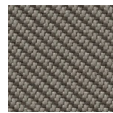
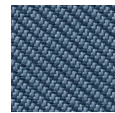
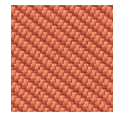
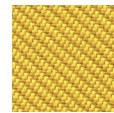
OOC01
FlotsamOOC08
BayOOC14
RiptideOOC13
PaddleOOC11
NeptuneOOC05
CoralOOC07
Barrier

Yoredale - by Camira

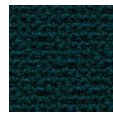
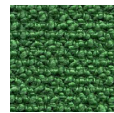
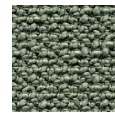
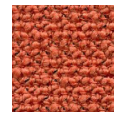
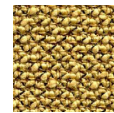
UDA08
GayleUDA25
LeyburnUDA17
RibbleUDA10
CrayUDA04
HardrawUDA02
KidstoneUDA03
AskriggUDA05
Simonstone

Vidar - by Kvadrat



0182



0133

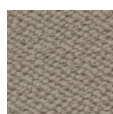

0222

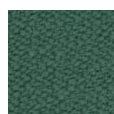

0943

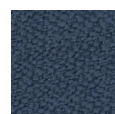

0733

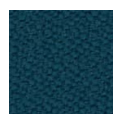

0872

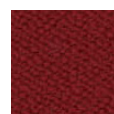

0582



0472