

# PANTHELLA 160 PORTABLE

This portable table lamp emits a glare-free, soft, and comfortable light. The metal shade variants reflects the light downwards and provides pleasant illumination created by the inner white painted shade and the reflection from the trumpet-shaped stem. The opal acrylic variants provides gentle illumination and subtle ambience due to the transparency and the reflection of the downward light on the inner side of the shade.

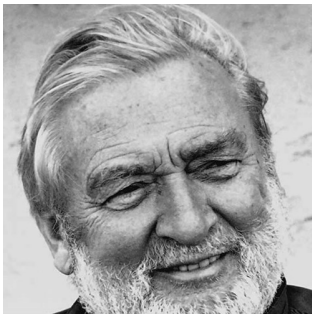

## Verner Panton

Verner Panton (1926-1998) is famous for his inspirational and colorful personality. A unique person with a special sense for color, shape, light function and space. Over the course of his career, Panton introduced a series of modern lamps with personalities unlike any of his Scandinavian contemporaries.



**louis  
poulsen**

## Product info

### Information

Please note that Panthella Portable comes with a USB cable but without adapter and Qi charger. Separate USB adapter is available as accessory. Compatible with standard USB adapters (Min 1.5A) and Qi wireless chargers. White cable for White Opal and Pale Rose variants. Black cable for other variants.

### Mounting

Cable length: 1.5m. Power: USB cable for standard USB adapter (min. 1.5A) or Qi wireless charger. White light indicator on base when charging. Light control: Switch on base. Batteries: 3 x AA NIMH , rechargeable and replaceable. Battery lifetime: 5 hours @ 100%. Step dim, short press: 0%/10%/33%/100%. Function to set a fixed light level.

### Finish

White Opal Acrylic shade with white stand. Grey Opal Acrylic shade with high lustre chrome stand. Pale Rose, Pale Blue or Coral, powder coated.

### Materials

Shade: Deep drawn steel or injection moulded opal grey acrylic or white opal acrylic. Base and housing: Die cast aluminium

### Sizes and weights

Width x Height x Length (mm) | 160 x 232 x 160 Max 0.4 kg | 160 x 238 x 160 Max 0.4 kg

### Class

Ingress protection IP44. Electric shock protection III.

### Light source

LED 2700K 2.5W

Lumen: 81

### Information

Please note that Panthella Portable comes with a USB cable but without adapter and Qi charger. Separate USB adapter is available as accessory. Compatible with standard USB adapters (Min 1.5A) and Qi wireless chargers. White cable for White Opal and Pale Rose variants. Black cable for other variants.



## Product family



Panthella 400 Table Lamp



Panthella Floor



Panthella 250 Table Lamp





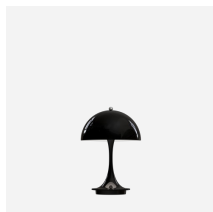





Panthella 320 Table Lamp



Panthella Portable Metal

## Product variants

Colour	Cable type	Light source	Lumen
 Black	Blk pl	LED 2700K 2.5W	150
 Coral metal	Wht pl		81
 Grey opal acryl			
 Orange			
 Pale blue			
 Pale rose			
 White			
 White opal acryl			

# Design

Verner Panton

# Weight

Min: 0.4 kg Max: 0.4 kg

# Finish

Black, Coral metal, Grey opal acryl, Orange, Pale blue, Pale rose, White, White opal acryl

# Light distribution diagrams

Cartesian

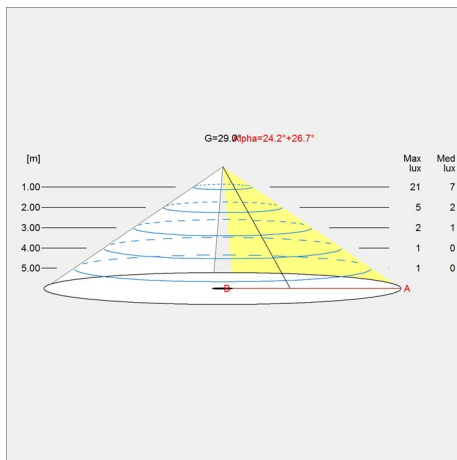

Isolux

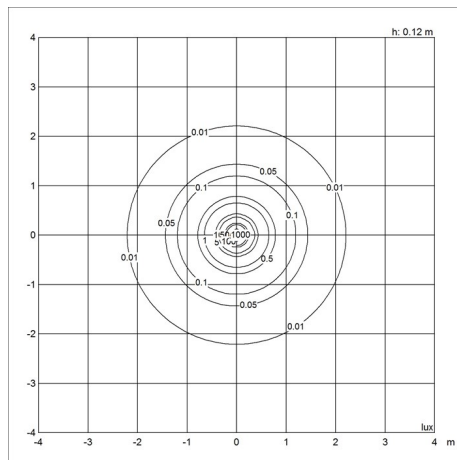

Polar

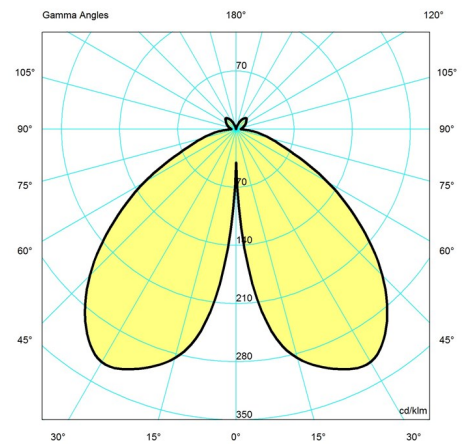

# Spare parts & accessories

## Panthella 160 Portable

Product	Variant number
Panthella Portable USB adaptor, white	5744166674
Panthella Portable shade opal	5744166742
Panthella Portable top nut	5744166755
Panthella Portable diffuser w/screws	5744168083
Panthella Portable USB cover, black	5744168407
Black USB adaptor	5744168410
Panthella Portable shade opal grey	5744168096
Panthella Portable Pale Blue shade	5744612665
Panthella Portable Coral shade	5744612678
Panthella Portable V2 rubber pad w/screws	5744612762
Panthella Portable shade pale rose	5744902090