

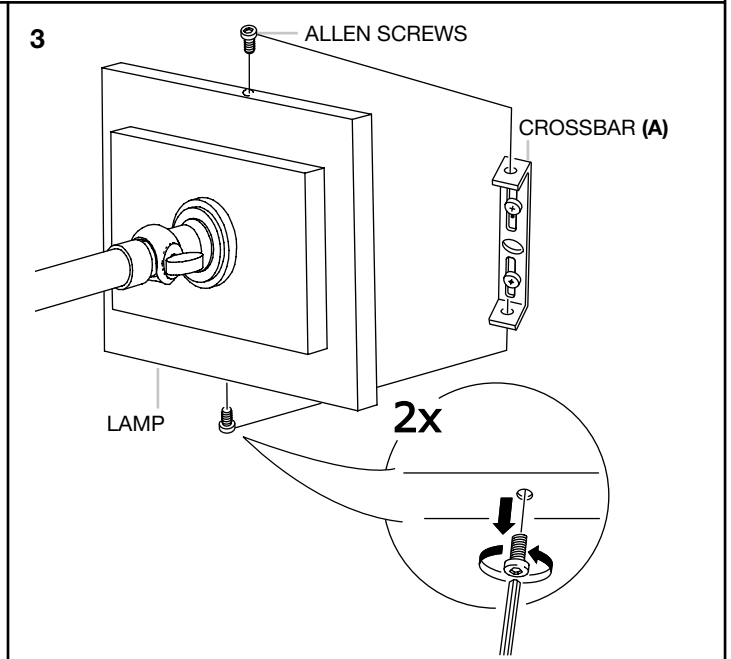

E I C H H O L T Z

111625 WALL LAMP PACIFIC

ASSEMBLY INSTRUCTION

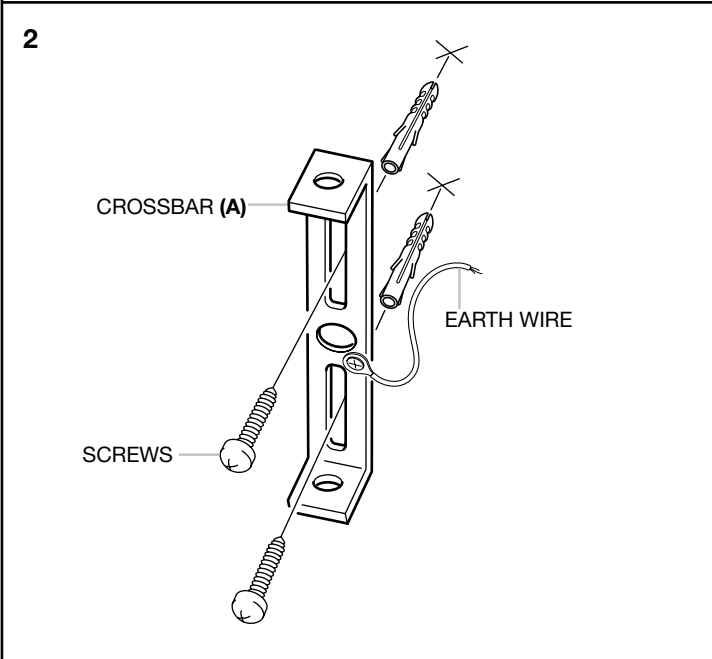
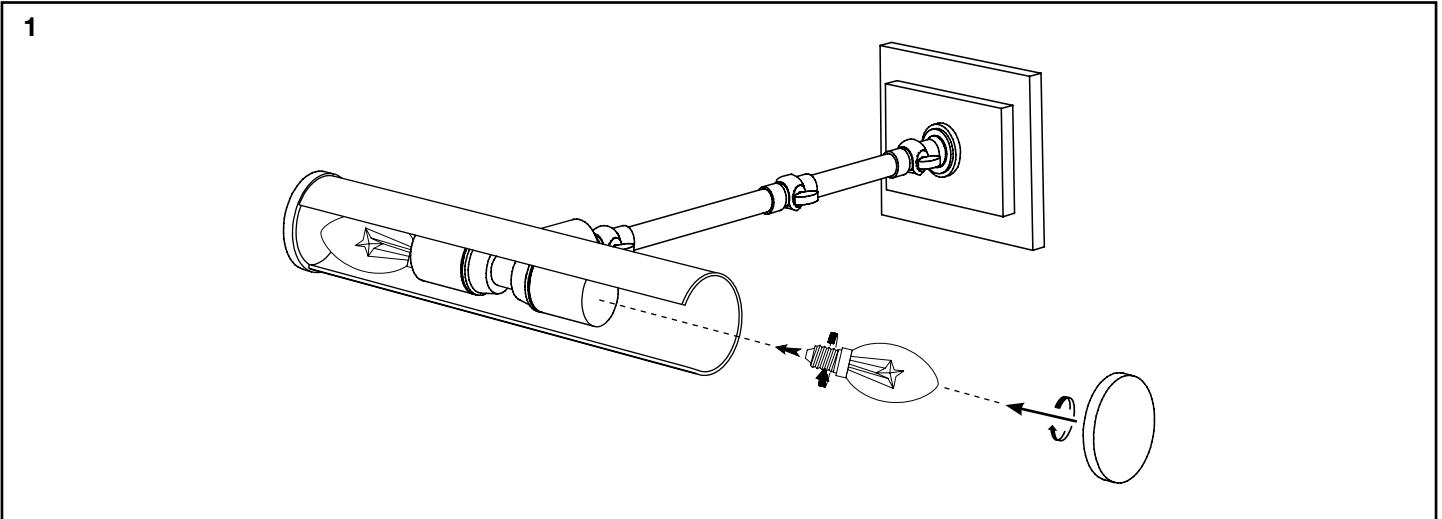

Turn off the electricity supply at the main circuit panel before installing.
Do not connect the electricity supply until your luminaire is fully assembled and installed.

If needed unscrew the end caps to place the bulbs (not included).

Fix the crossbar (A) to the wall by using wall mounting plugs and screws suitable to your wall type.

Open the wire connector and connect the 3 wires according to their colours. Brown is the live wire, blue is the neutral wire, green/yellow is the earth wire.

Place the lamp over the cross bar and fix it securely with the allen screws (B) supplied.

Adjust the position of the lamp by loosening and tightening the wingnuts one by one (C).

