

Shelley



nicoline

Descrizione modello - *Model Description*

Dimensioni - *Dimensions*

Composizioni consigliate - *Recommended compositions*

nicoline.it

ITALY - C.da Parchi Calia sn Z.I. - 70022 Altamura – BA - Telefono: +39 080 3101487

UNITED STATES - Nicoline Salotti Inc. po box 38783 - Greensboro – NC 27438 - Phone: +1 (336) 259 9881

SINGAPORE - 23 Genting Road #06-01 - Chevalier House Singapore 349481 - Telefono: +65 8168 3354

SHELLEY

Design Application N°402016000053464



Frontale/Front



Laterale/Depth

61 cm - 24"

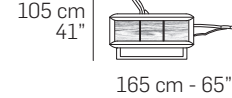
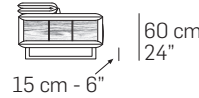
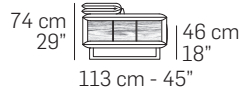

Caratteristiche standard

- Struttura in legno e multistrato. Molleggio seduta e spalliera con cinghie elastiche.
- Imbottiture in poliuretano espanso ecologico a cellula aperta con densità differenziate.
- Rivestimento in pelle o tessuto. Tutti i rivestimenti sono fissi.
- Versioni recliner con meccanismo elettrico indipendente sia per la seduta che per il poggiatesta.
- Versioni fisse con meccanismo poggiatesta manuale ad unica posizione e azionato da pistone a gas.
- Piedi in metallo Lucido (Cod.30), Satinato (Cod.31), Canna di fucile (Cod.50), Bronzo anticato (Cod.52).
- Libreria interno bracciolo in legno verniciata nei colori RAL opaco: RAL 7006 - RAL 7024 - RAL 7044 - RAL 8019.
- Elemento prisma (Cod.8100) dotato di vano contenitore con coperchio/vassoio removibile e vano portariviste con doppio ingresso USB. Disponibili in legno verniciati nei colori RAL opaco: RAL 7006 - RAL 7024 - RAL 7044 - RAL 8019.
- Inserimento letto non possibile.
- Lato componibile non rifinito.

Caratteristiche optional su richiesta con maggiorazione

- Batteria al litio per movimentare il meccanismo in assenza di elettricità. Considerare una batteria per ogni seduta recliner.
- Solo per le versioni dove previsto, il lato componibile può essere rifinito.
- Per il multi rivestimento il prezzo va incrementato del 7%. Per maggiori dettagli fare riferimento al paragrafo "NOTE" posto nelle prime pagine del listino.

Note

- Le versioni recliner sono consegnate a moduli separati

Standard features

- Frame: wooden structure, seat and back suspensions in reinforced elastic webbing.
- Paddings in eco-friendly open cell polyurethane foam with different densities.
- Covering in leather or fabric. Not removable coverings.
- Electrical independent mechanism both on the footrest and headrest for reclining versions.
- Manual adjustable headrest with hydraulic cylinders, for fixed versions.
- Legs in Shiny metal (Cod.30), Satin metal (Cod.31), Gunmetal (Cod.50), Antique bronze (Cod.52).
- Arm with wooden bookcase painted in the following matte RAL colors: RAL 7006 - RAL 7024 - RAL 7044 - RAL 8019.
- Prism element (Cod.8100) equipped with storage compartment with removable top/tray and magazine rack with double USB port. Available painted in the following matte RAL colors: RAL 7006 - RAL 7024 - RAL 7044 - RAL 8019.
- No bed version available.
- Sectional sides not finished.

Optional features available upon request with upcharge

- Lithium battery kit available. One battery pack for each reclining seat.
- Sectional sides finished (if possible).
- 7% upcharge for combined coverings. Please refer to the notes at the beginning of pricelist.

Notes

- All reclining versions are made and delivered as separate elements.



Piede in metallo // Metal leg

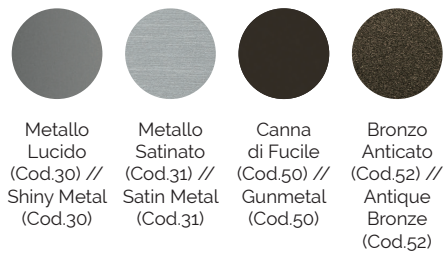

Libreria // Bookcase

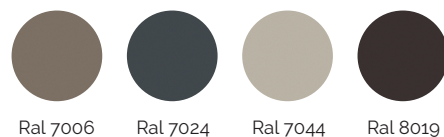

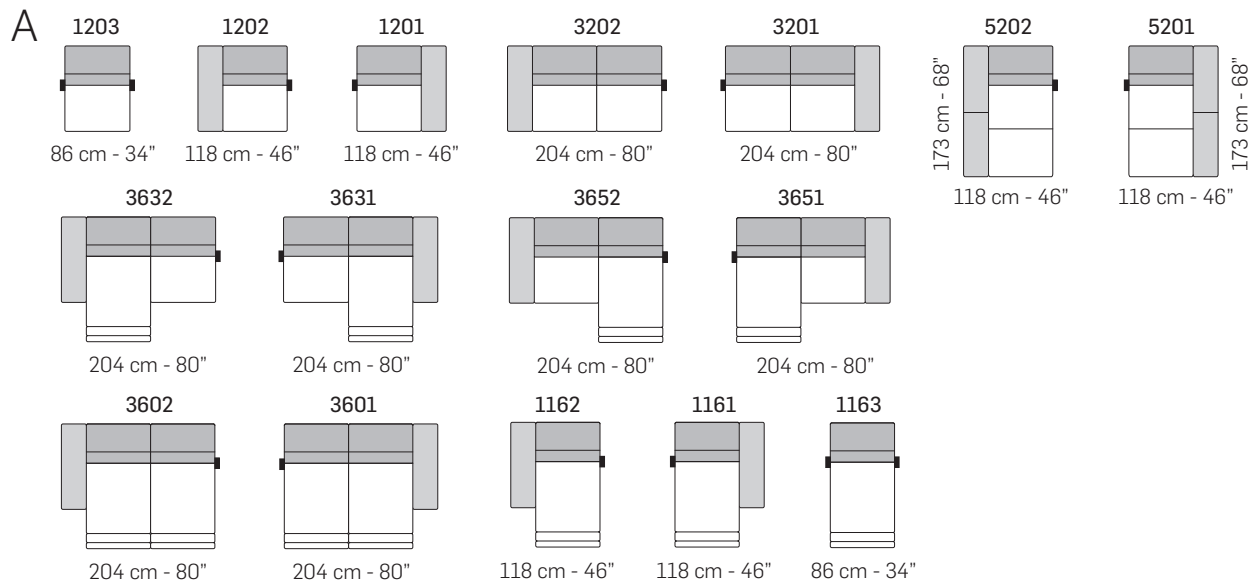
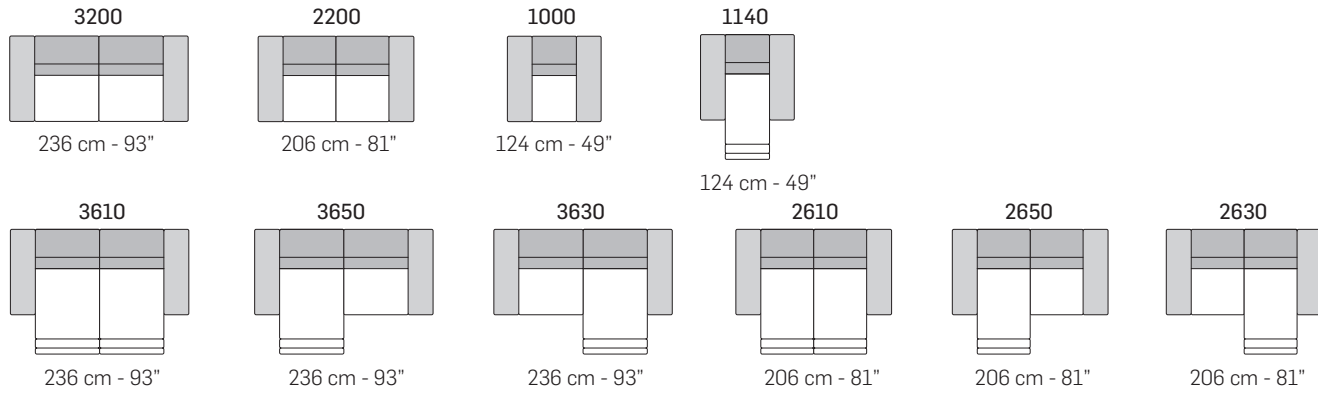

tutti gli elementi del gruppo A hanno lo stesso modulo di seduta - all items in group A have the same seat width

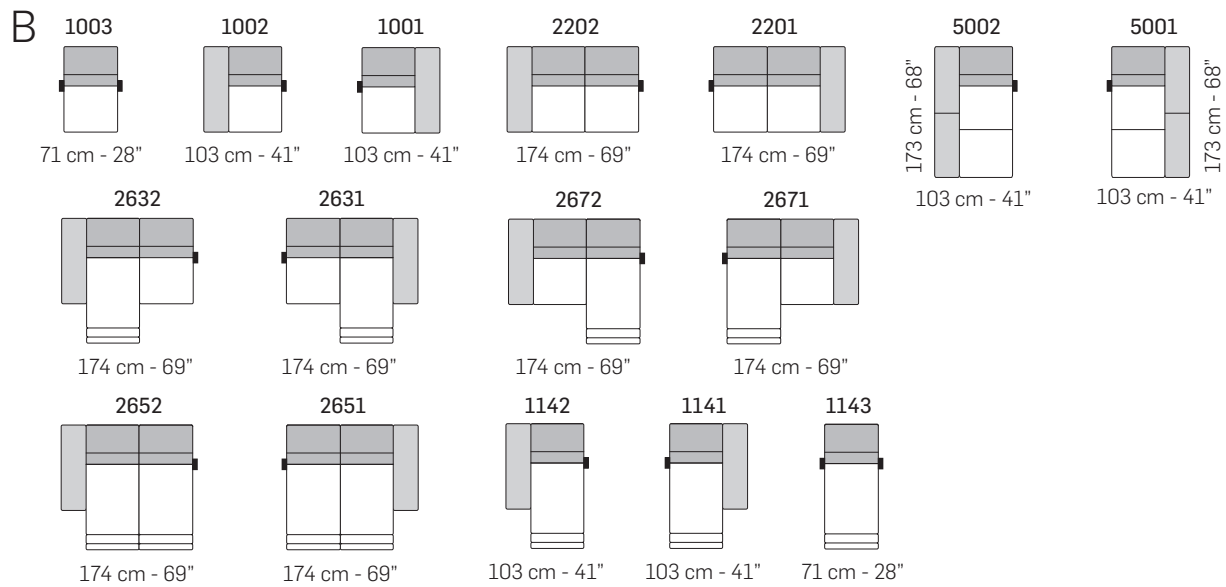

tutti gli elementi del gruppo B hanno lo stesso modulo di seduta - all items in group B have the same seat width

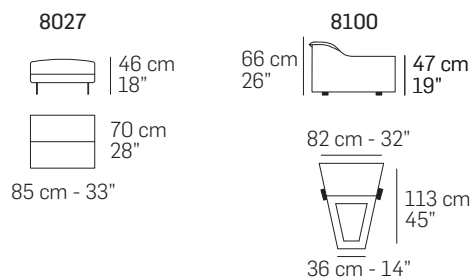

COMPOSIZIONI CONSIGLIATE / SUGGESTED COMPOSITIONS

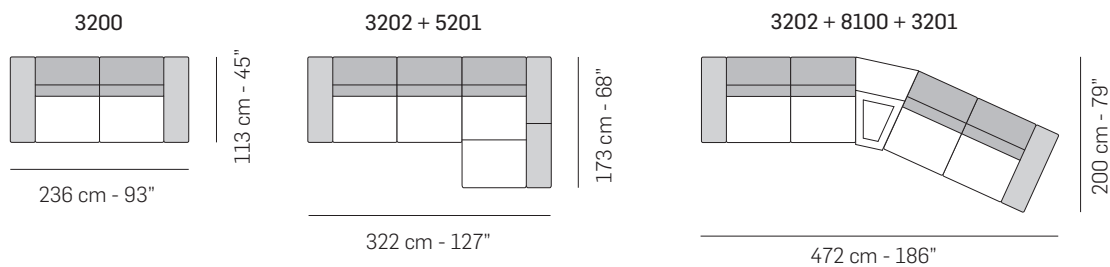

Scala 1:100
Ratio 1 to 100

Legenda / Legend

- Spalliera / Back Cushions
- Bracciolo / Armrest
- Aggancio Componibile / Connector
- Poggiareni / Kidneyrest
- Seduta / Seat Cushions

Note / Notes

Nicoline si riserva il diritto di apportare in ogni momento modifiche tecniche ed estetiche / Nicoline reserves the right to change, at any time and without prior warning, technical and aesthetic specifications of the articles.