

Egeo



nicoline

Descrizione modello - *Model Description*

Dimensioni - *Dimensions*

Composizioni consigliate - *Recommended compositions*

nicoline.it

ITALY - C.da Parchi Calia sn Z.I. - 70022 Altamura – BA - Telefono: +39 080 3101487

UNITED STATES - Nicoline Salotti Inc. po box 38783 - Greensboro – NC 27438 - Phone: +1 (336) 259 9881

SINGAPORE - 23 Genting Road #06-01 - Chevalier House Singapore 349481 - Telefono: +65 8168 3354

EGEO

Design Application N° 402017000039849



frontale // front



laterale // depth

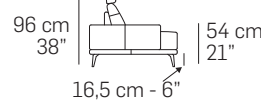
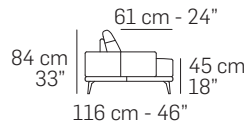

24 cm - 9"

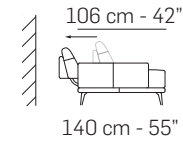

Caratteristiche standard

- Struttura in legno e multistrato, molleggio seduta con cinghie elastiche.
- Imbottiture in poliuretano espanso ecologico a cellula aperta con densità differenziate.
- Rivestimento in pelle o tessuto. Tutti i rivestimenti sono fissi.
- Rivestimento in pelle con seduta trapuntata.
- Rivestimento in tessuto con seduta senza trapuntatura.
- Piede in metallo Lucido (Cod.30), Satinato (Cod.31), Canna di fucile (Cod.50), Bronzo anticato (Cod.52).
- I cuscini di schienale sono dotati di meccanismo "pendular".
- Cucitura Cod.03 per rivestimento in tessuto.
- Cucitura Cod.07 per rivestimento in pelle.
- Inserimento letto non possibile.
- Lato componibile non rifinito.

Caratteristiche optional su richiesta senza maggiorazione

- Disponibile con cucitura a contrasto, per la scelta del colore fare riferimento ai codici del campionario pelli.

Caratteristiche optional su richiesta con maggiorazione

- Solo per le versioni dove previsto, il lato componibile può essere rifinito
- Poggiatesta (Cod.9900) con imbottitura in poliuretano espanso ecologico a cellula aperta e rivestimento sfoderabile.
- Per il multi rivestimento il prezzo va incrementato del 7%. Per maggiori dettagli fare riferimento al paragrafo "NOTE" posto nelle prime pagine del listino.

Note

- Non è possibile applicare altre cuciture.
- Per alcuni tessuti e velluti l'azienda si riserva di applicare la cucitura Cod.00 / Cod.03 (vedi immagine).

Standard features

- Frame: wooden structure, seat suspensions in reinforced elastic webbing.
- Paddings in eco-friendly open cell polyurethane foam with different densities.
- Covering in leather or fabric. Not removable coverings.
- Quilted seat for leather coverings.
- Not quilted seat for fabric coverings.
- Legs in Shiny metal (Cod.30), Satin metal (Cod.31), Gunmetal (Cod.50), Antique bronze (Cod.52).
- Back cushion with pendular mechanism on all elements.
- Stitching type Cod.03 for fabric coverings.
- Stitching type Cod.07 for leather coverings.
- No bed version available.
- Sectional sides not finished.

Optional features without any upcharge

- Contrast stitching available. Please refer to our leather collection for a thread color indication.

Optional features with upcharge

- Sectional sides finished (if possible).
- Headrest (Cod.9900) in eco-friendly open cell polyurethane foam and removable covering.
- 7% upcharge for combined coverings. Please refer to the notes at the beginning of pricelist.

Notes

- Different stitchings not available.
- For some fabrics and velvets production dept. must apply the stitching Cod.00 / Cod.03 (as per picture below).



Piede in metallo // Metal legs

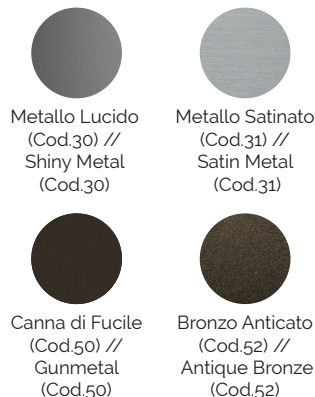

Cuciture // Stitching

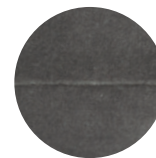

Cod.00

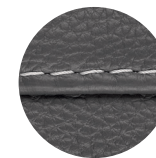

Cod.03



Cod.07

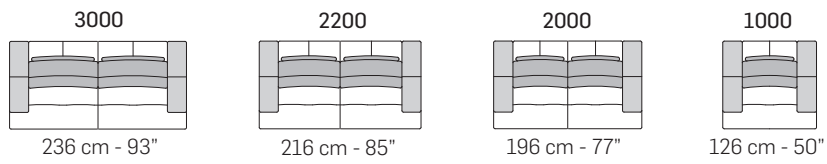

A

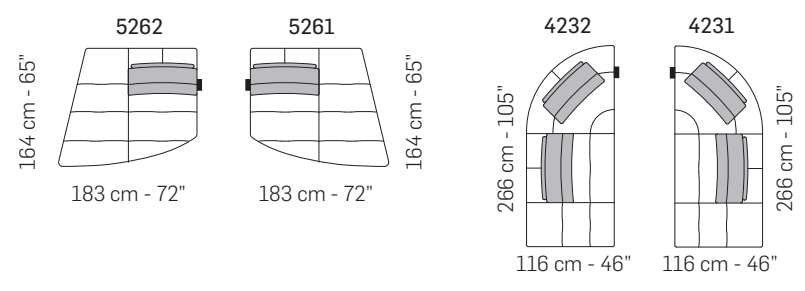
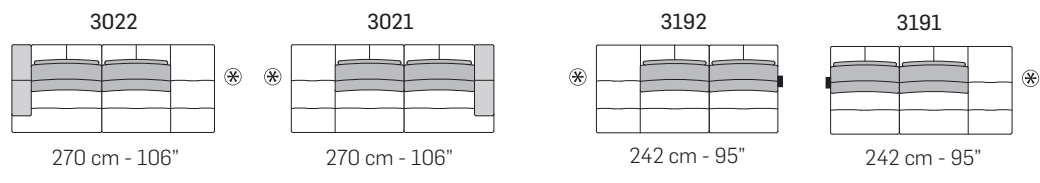
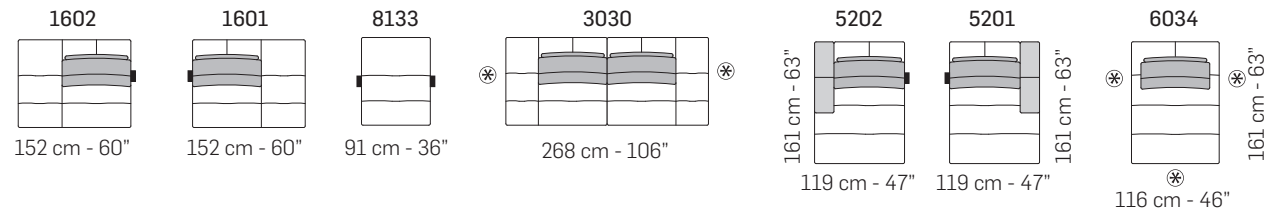
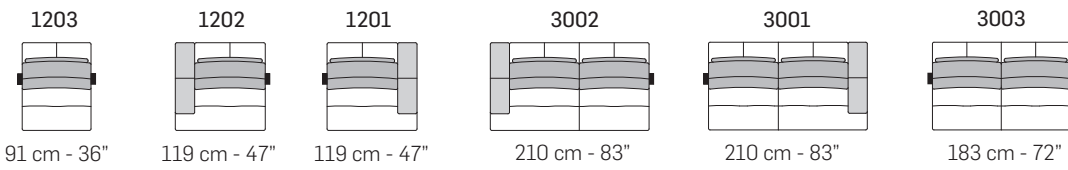

tutti gli elementi del gruppo A hanno lo stesso modulo di seduta - all items in group A have the same seat width

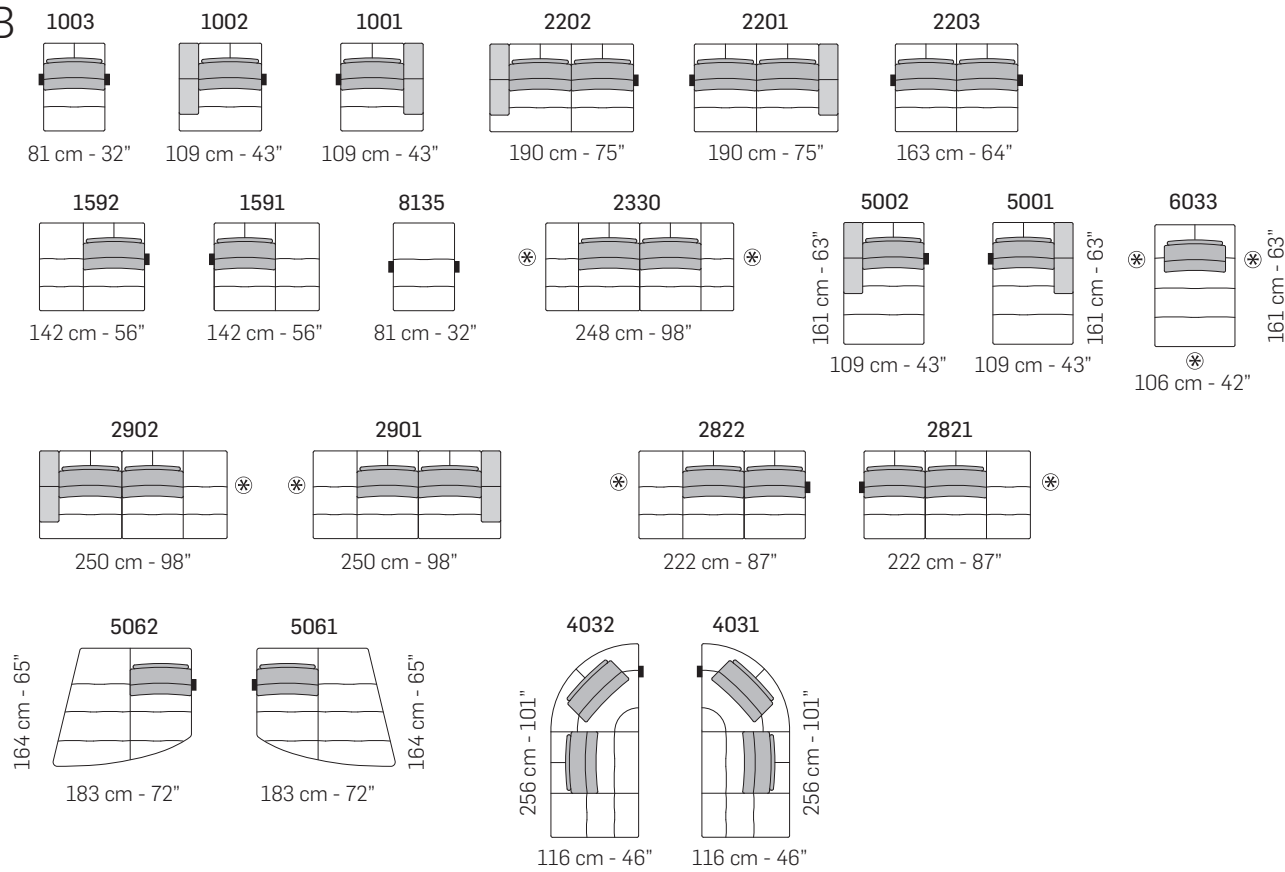
B

tutti gli elementi del gruppo B hanno lo stesso modulo di seduta - all items in group B have the same seat width

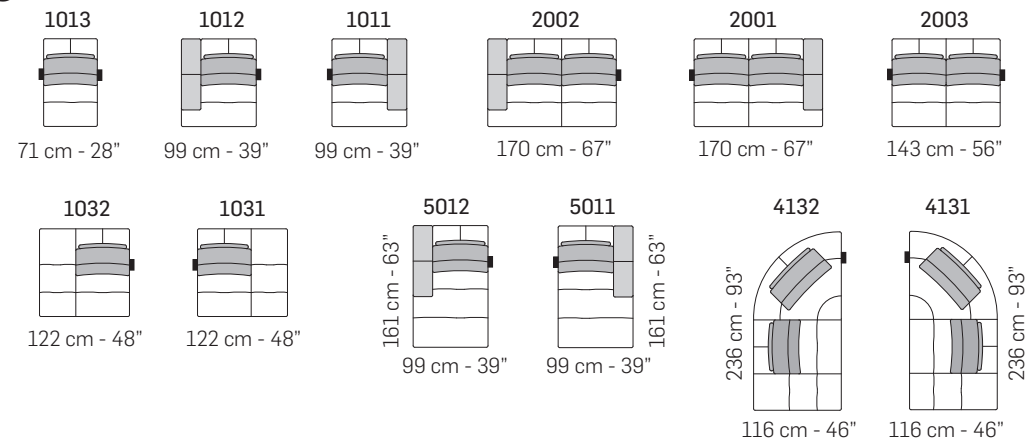
C

tutti gli elementi del gruppo C hanno lo stesso modulo di seduta - all items in group C have the same seat width

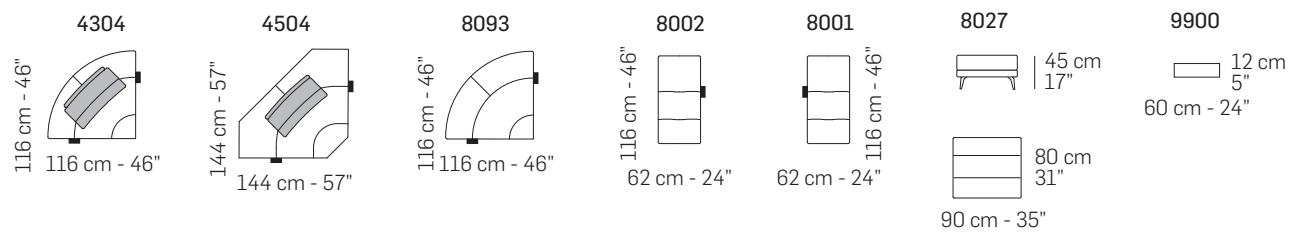

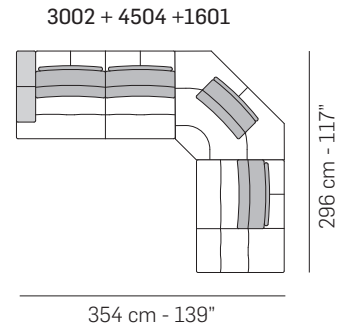
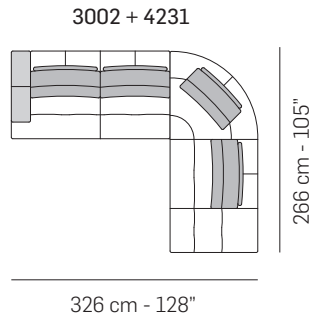
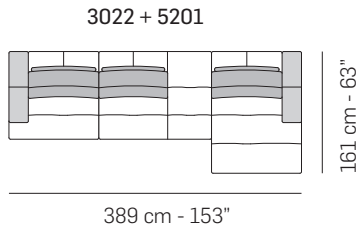

Scala 1:100
Ratio 1 to 100

Legenda / Legend

- Spalliera / Back Cushions
- Bracciolo / Armrest
- Poggiareni / Kidneyrest
- Seduta / Seat Cushions

⊗ Lato terminale sempre rifinito e agganciabile agli elementi componibili / Terminal side is always finished and it can also be connected to modular elements

■ Aggancio Componibile / Connector

Note / Notes

Nicoline si riserva il diritto di apportare in ogni momento modifiche tecniche ed estetiche / Nicoline reserves the right to change, at any time and without prior warning, technical and aesthetic specifications of the articles.